

28.850

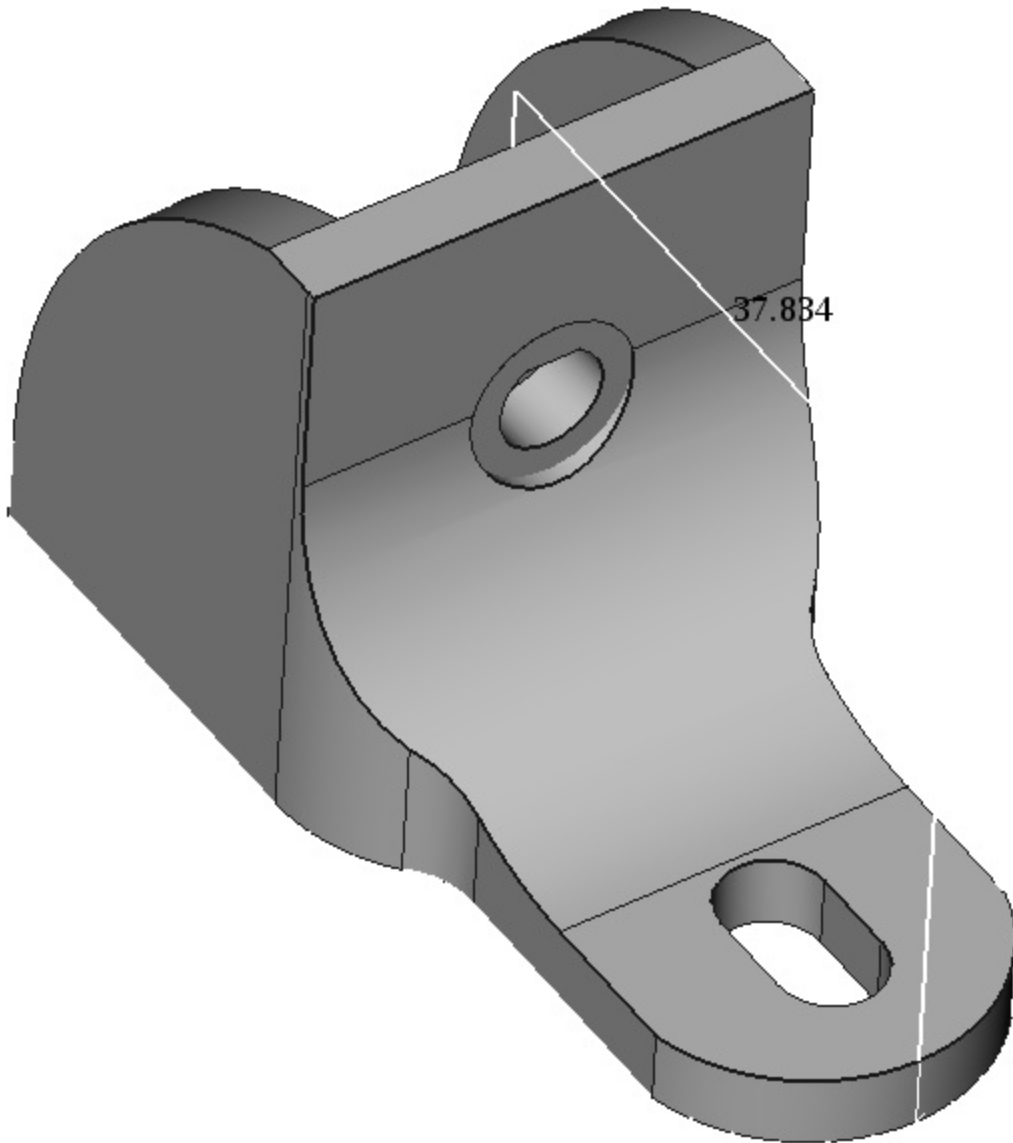

37.834

34.000

4.000